

Portable Icemaker



User Manual
HPIM35W

Haier

Quality · Innovation · Style

IMPORTANT SAFEGUARDS

When using electrical appliances, basic safety precautions should always be followed, including the following:

1. **Read all instructions carefully.**
2. To protect against risk of electric shock, do not immerse cord, plug or any parts of the unit in water or other liquids.
3. Close supervision is necessary when using this appliance near children. This appliance is not suitable for use by children.
4. Never leave an appliance unattended while in use.
5. Do not place an appliance on or near a hot gas or electric burner, or in a heated oven. Do not place on top of any other appliance.
6. Do not let the power cord of an appliance hang over the edge of a table or countertop or touch any hot surface.
7. Do not operate any electrical appliance with a damaged cord or plug or after the appliance malfunctions or has been dropped or damaged in any manner. If damage is suspected, contact the nearest authorized service center for examination, repair or electrical or mechanical adjustment.
8. Unplug from power outlet when not in use, before putting on or taking off attachments, and before cleaning.
9. The use of accessory attachments not recommended by the appliance manufacturer may cause fire, electric shock or injury.
10. Avoid contact with moving parts when the unit is in operation.
11. Never touch the cooling elements when the unit is in operation.
12. Do not use outdoors.
13. Do not use appliance for other than its intended use.

SAVE THESE INSTRUCTIONS HOUSEHOLD USE ONLY

Polarized Plug

This appliance is equipped with a polarized plug (one blade is wider than the other). To reduce the risk of electric shock, this plug is intended to fit into a polarized outlet only one way. This is a safety feature. If the plug does not fit fully into the outlet, try reversing the plug. If it still does not fit, contact a qualified electrician. Do not attempt to modify the plug in any way. Do not defeat the safety purpose of this polarized plug.

A short power-supply cord is provided to reduce the risk resulting from becoming entangled in or tripping over a longer cord. Avoid the use of an extension cord because it may overheat and cause a risk of fire. However, if you must use an extension cord, the marked electrical rating should be at least as great as the electrical rating of the appliance. The extension cord should be a minimum size of No. 16AWG and rated no less than 1800W. The longer cord should be arranged so that it will not drape over the counter-top or tabletop where it can be pulled on by children or tripped over.

Thank you for using our Haier product. This easy-to-use manual will guide you in getting the best use of your icemaker.

Remember to record the model and serial number. They are on a label in back of the icemaker.

Model number

Date of purchase

Staple your receipt to your manual.

You will need it to obtain warranty service.

Table Of Contents

	PAGE
Important Safeguards	1
Parts and Accessories	4
Operating Instructions	5
Pre-Operating Instructions.....	5
Operating Instructions.....	6
Operating Process	7
Cleaning and Maintenance	8
Troubleshooting Guide	9
Limited Warranty	10

Parts and Accessories

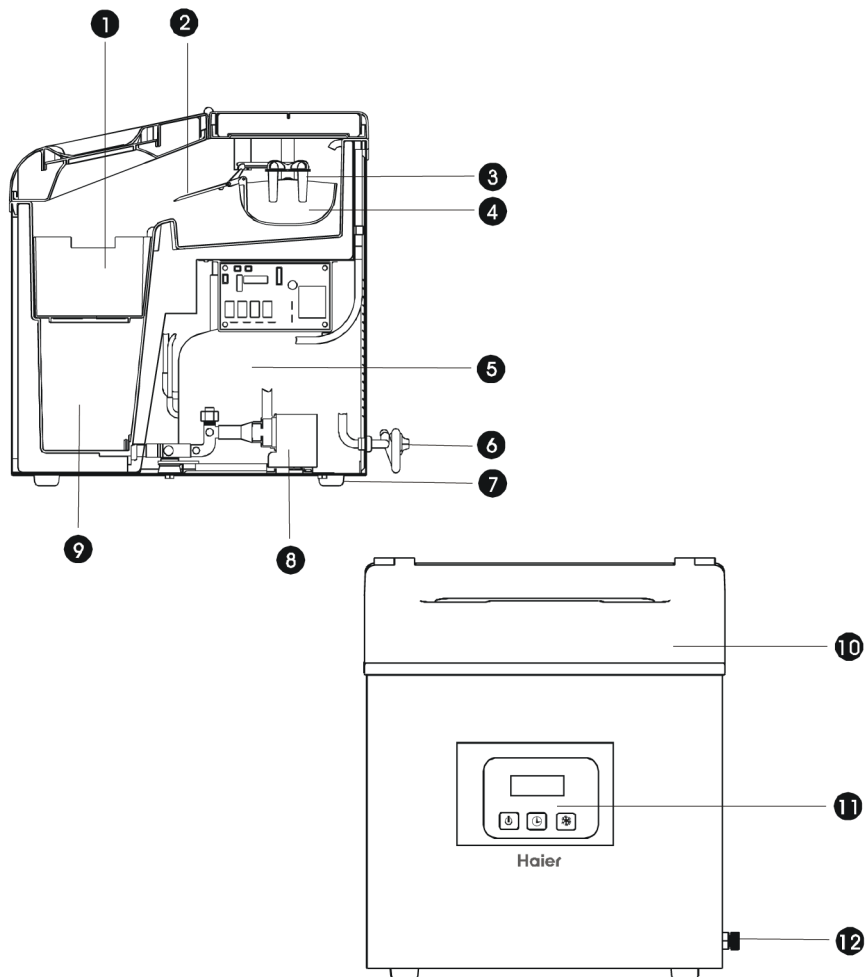

1. Ice Storage Basket
2. Ice Pusher
3. Evaporator Rods
4. Water Box
5. Compressor
6. Power Cord

7. Pad
8. Water Pump
9. Water Storage Tank
10. Lid
11. Control Panel
12. Drainage Plug

Operating Instructions



Pre-Operating Instructions

1. The incline angle of the cabinet should not exceed 45° during transportation. Do not turn the icemaker upside-down. Doing so could cause the compressor or refrigerating system to operate incorrectly.
2. The icemaker should be placed on a dry and level surface away from any heat sources and corrosive gases.
3. Before using the icemaker for the first time, wait 12 hours after positioning in its proper place.
4. Make sure that the unit is unplugged. Clean the inside of the icemaker thoroughly by wiping it with a soft, damp cloth. Wipe the inner liner, ice collecting tray, water box, ice pusher and evaporator rods.

Operating Instructions

1. Open the lid, remove the ice storage basket, and fill the water storage tank with drinkable (tap, purified or bottled) water. Replace the ice storage basket. Make sure that the water level does not reach the bottom of the ice storage basket. Close the cover.

Note: During the operation process, if the level of water in the water storage tank becomes too low, the machine will automatically stop operating and the LCD will display "POUR".

2. Plug the unit into a grounded outlet. Push the  button on the control panel to turn on the machine.
3. Press the  button to select the delayed start time in half-hour increments of up to 12 hours. Or to begin the ice-making process immediately, skip to the next step.
4. Press the  button to select the desired size of the ice cubes. The LCD display will indicate the setting.

* = Small ice cubes (Approx. 9 minutes)

** = Medium ice cubes (Approx. 10 minutes)

*** = Large ice cubes (Approx. 11 minutes)



5. Press the  button to begin operation.

Note: To stop the operation, press the  button again.

Operating Process

1. Water is pumped from the water storage tank to the water box, which may take up to 48 seconds.
2. The ice-making cycle begins when the evaporator rods are dipped into the water box.
3. It will take approximately 9-11 minutes for each ice-making cycle, depending upon the size selected. The larger the size, the more time is needed to make the ice. After the cycle is finished, the water box will tilt forward and the remaining water will flow back into the water storage tank. The evaporator rods will then release the ice cubes.

Note: If the ambient temperature is below 59° F, then small or medium ice cube sizes are suggested to prevent ice cubes from fusing together.

4. Approximately 60 seconds later, the water box will tilt backwards and the ice pusher will push the ice into the ice storage basket. After the water box flips back to its original position, the next ice-making cycle will begin.
5. When the maximum capacity of ice cubes is collected and the ice reaches the temperature sensor, the icemaker will automatically stop operating. The LCD display will show "FULL". Remove the ice from the ice storage basket. Then replace the basket into the machine, making sure that the basket is pushed back to its original position. This will ensure that the temperature sensor is above the basket so that the machine operates properly.
6. To continue making ice, check that there is water in the water storage tank. If there is no water in the water storage tank, and no water is being pumped into the water box, the operation will stop and the LCD display will show "POUR". Fill the water storage tank with water and press the  button for the icemaker to begin operating again.
7. When the LCD display shows "----", press the  button again to restart the machine. If the compressor stops for any reason such as water shortage, too much ice, power off, etc., do not restart the machine right away. Wait at least 3 minutes before restarting the machine.

Cleaning and Maintenance

1. To ensure the cleanliness of the ice cubes, the water in the water storage tank must be replaced every 24 hours.
2. The filter (located at the bottom right of the water storage tank) needs to be cleaned regularly so that impurities in the water do not enter the water pump and affect the normal operation of the machine. The filter may be cleaned with a small flexible toothbrush.
3. Unscrew the drainage plug to release the remaining water in the water storage tank when the icemaker will not be used for an extended period of time.
4. Clean the icemaker regularly. When cleaning, make sure that the power has been turned off. Remove the plug from the outlet and remove the ice cubes. Use a mild detergent diluted in water and wipe with a soft towel or sponge to clean the inside and outside surfaces of the unit. Do not spray any strong cleaning solutions on the unit. Avoid using harsh liquids such as acids and gasoline to clean the unit.
5. When plugging or unplugging the unit, pull directly on the plug. Never pull on the power cord.
6. If the power cord is damaged, please contact an authorized service center for repair or replacement.
7. To avoid lime scale buildup, drain any remaining water from the water storage tank after each use and clean the appliance once a week.

Specifications

Electric Shock Protection: Class I

Power Input: AC120V/2.3A

Dimensions: 15.75"(w) x 14.17"(d) x 15.98"(h)

Refrigerant: R134a

Troubleshooting Guide

Problem	Possible Causes	Solution
The compressor makes a buzzing noise when the machine is on.	The voltage is lower than required. This unit requires a minimum of 120 volts.	Turn off the icemaker. Make sure the voltage is 120v and restart.
The LCD display shows "POUR".	There is no water in the water storage tank or the water level is too low.	Fill the water storage tank with water and restart the unit.
	The filter is blocked.	Clean the filter with a soft, flexible toothbrush.
The LCD display shows "FULL"	There is too much ice in the ice storage basket.	Remove some ice from the ice storage basket.
	The temperature is too low.	Place the icemaker in a warmer place.
There is no display on the LCD screen.	The fuse is blown.	Replace the fuse.
The ice cubes are fusing together.	The ice-making time is too long.	Stop the machine and reset the ice-making time. Start the machine after the ice block melts.
	The water temperature in the inner liner is too low.	Replace the water in the inner liner. The suggested water temperature is 44.6° to 77°F.
Water is not freezing during the normal ice-making cycle.	The refrigerant is leaking. There is a block in the refrigerating system.	Contact an authorized service center.

Limited Warranty

Full One Year

This warranty covers all defects in workmanship or materials for a period of 12 months from the date of purchase, provided you are able to present a valid proof-of-purchase (the original receipt)

Exceptions: Commercial or Rental Use Warranty is 90 days from date of original purchase.

This warranty covers appliances within the Continental United States, Puerto Rico and Canada.

What is not covered by this warranty:

Damage from other than normal use or improper installation.

Damage from misuse, abuse, accident, alteration, lack of proper care and maintenance.

Failure caused by build-up of food matter or water deposits.

Product, whose rating label has been removed or altered.

Product serviced by other than authorized service center.

Replacement or repair of household fuses, circuit breakers or wiring.

Labor, shipping charges and replacement of defective parts beyond the initial 12-month period.

Do not return this product to the store.

If you need assistance with this product, please contact "Haier Customer Satisfaction Service at 1-877-337-3639 between 9:00 AM and 5:00 PM (EST) Monday to Friday.

Before calling, please have the following information available:

Model number of your appliance. The name and address of the store you purchased the unit from and the date of purchase. A clear description of the problem.

Haier will repair or replace any part free of charge including labor that fails due to a defect in materials or workmanship, or replace with a comparable model.

THIS LIMITED WARRANTY IS GIVEN IN LIEU OF ALL OTHER WARRANTIES, EXPRESSED OR, INCLUDING THE WARRANTIES OF MERCHANTABILITY AND FITNESS FOR A PARTICULAR PURPOSE.

The remedy provided in this warranty is exclusive and is granted in lieu of all other remedies.

This warranty does not cover incidental or consequential damages, so the above limitations may not apply to you. Some states do not allow limitations on how long an implied warranty lasts, so the above limitations may not apply to you.

This warranty gives you specific legal rights, and you may have other rights, which vary, from state to state.

Haier America
New York, NY 10018

IMPORTANT

Do Not Return This Product To The Store

If you have a problem with this product, please contact the "Haier Customer Satisfaction Center" at 1-877-337-3639.

DATED PROOF OF PURCHASE REQUIRED FOR WARRANTY SERVICE

120V, 60 Hz

Made in China

Haier

**Haier America
New York, NY 10018**

Printed in China